

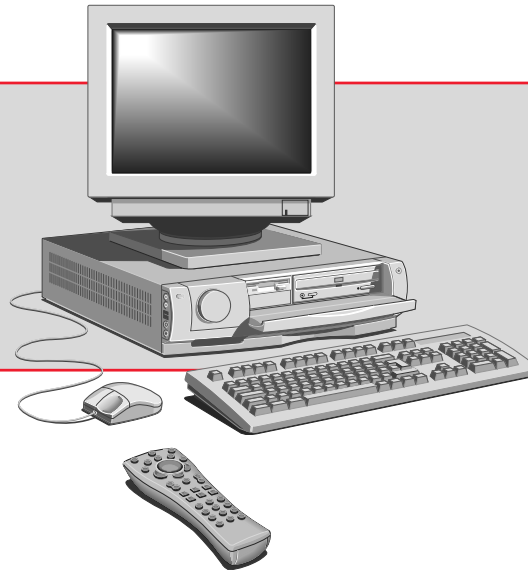

APRICOT MULTIMEDIA PCs

# Apricot MS SERIES

Owner's Handbook



Certificate No.'s:  
FM 1716 FS 21715 FS 30305

including  
**Quick Start  
Guide**

## APRICOT MS SERIES QUICK START GUIDE



---

**For your own safety**

*Read through the Safety & Regulatory Notices section at the start of the Owner's Handbook before using the computer for the first time.*

---

## Using the Welcome Mat

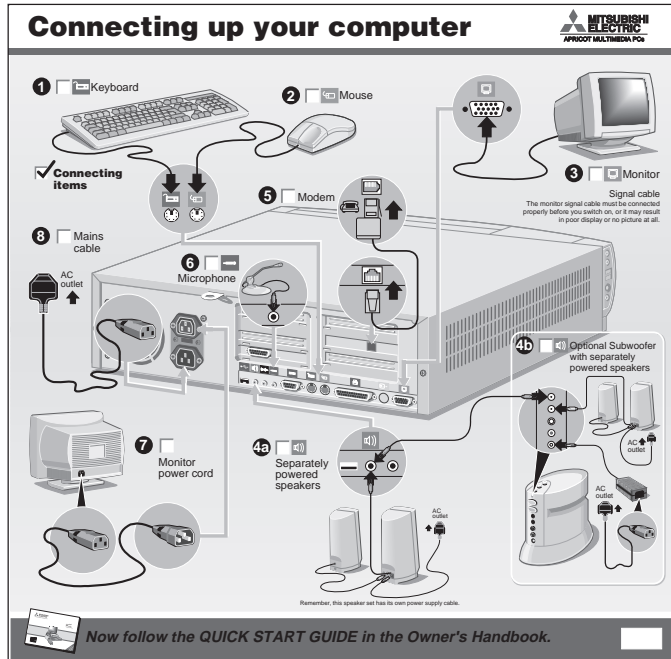

Use the Welcome Mat to help you unpack and connect the components of your new personal computer. The recommended order is:

1. Keyboard
2. Mouse
3. Monitor signal cable
4. Stereo speakers (and optional sub-woofer)
5. Modem cable
6. Microphone (optional)
7. Monitor power cord
8. System unit power cord

Once your computer is connected, switch on the power at the wall socket. The Power Mode light next to the POWER button (the large, round button on the front of the computer) should glow red to show that the computer is ready to start.

## The Power button

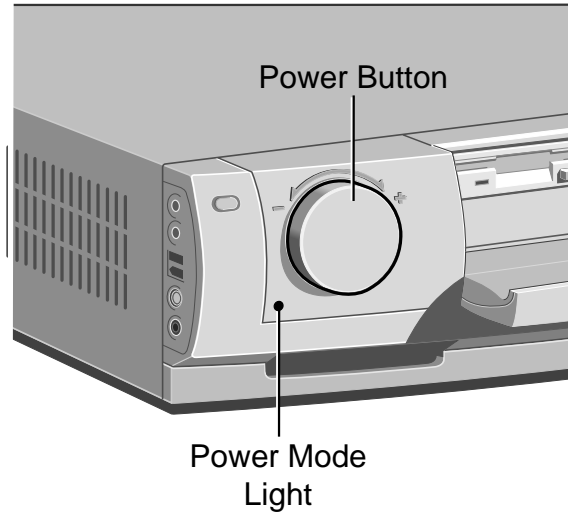

The POWER button is the large, round button on the front of the computer.

- ◆ Press the POWER button to turn on the computer, to put it to sleep, and to wake it up.
- ◆ Turn the POWER button to change the volume of sound through the computer's speakers.

The colour of Power Mode light shows whether the computer is in Off [red], On or Standby [green] or Suspend [yellow] mode.

The monitor has its own power button or switch; see the monitor's *User Guide* to find out where it is.

### Starting the computer

- ◆ Press the **POWER** button to turn on the computer.
- ◆ Turn on the monitor as described in its *User Guide*.

The colour of the Power Mode light turns from **red** to **green** to show that the computer is now working.

### Suspending the computer

Once Windows has started, you can give the **POWER** button a brief press to suspend the computer when you aren't using it. Alternatively, you can click the **Start** button in the Windows taskbar, then click **Suspend**.

To wake up the computer, you have to press the **POWER** button again – just moving the mouse or using the keyboard won't work.

While the computer is suspended its processor stops, its hard disk stops spinning and the monitor goes blank, but none of your files are lost.

In Suspend mode the Power Mode light is **yellow**.

---

### Note

*Future versions of Windows will allow you to redefine the **POWER** button so that when you press it the operating system shuts down and the PC goes directly into Off mode.*

---

### Automatic power saving

During periods of inactivity the computer automatically reduces the power consumption of idle components. For example, the monitor screen may go blank. This power-reduced state is known as Standby mode (the Power Mode light stays **green**). If the inactivity is prolonged the computer goes into full Suspend mode (the Power Mode light is **yellow**).

While in Standby mode you can move the mouse or press any keyboard key to resume working. Once the computer goes into Suspend mode only the **POWER** button can wake it.

You can adjust automatic power saving with the Power Management program, which is provided as part of the Easy Manager software collection.

## Shutting down the computer

To shut down the computer safely, do the following:

1. Wait until all the activity indicators on the front bezel show 'not busy'.
2. Turn off any attached peripherals, except for the monitor and other peripherals that are designed to be kept on permanently.
3. Click the **Start** button in the Windows taskbar, then click **Shut Down**. Select **Shutdown the computer** and click **Yes**.

The Power Mode light goes from **green** to **red**.

Note that you do not have to press the **POWER** button if Windows is running.

---

### **You don't have to turn off the monitor**

*Because the monitor gets its power from the computer, once you turn the monitor on you should never need to turn it off, except to move or open up the computer.*

---

## Emergency shut down

In exceptional circumstances, you can shut down your PC without shutting down Windows first. To do this, press *and hold down* the **POWER** button for at least four seconds.

The computer also shuts itself down if you press the **POWER** button in MS-DOS or before Windows starts.

---

### **Make sure it is an emergency!**

*In an emergency shut down, you may lose any recent changes made to the files you are currently working on. The Microsoft ScanDisk program will run automatically when the computer next starts, to check for disk errors.*

---

## Energy Star

The aim of these various power modes is to cut your electricity bill and conserve resources. **Energy Star** is an internationally recognised standard for such energy-efficient computer systems.

Your computer will always meet the Energy Star standard in Suspend mode, when the Power Mode light is **yellow**.

## **Registering Windows 95**

---

Your computer has the Microsoft Windows 95 operating system already in place or *pre-installed*, so that it is ready for you when you turn on the computer.

The first time you turn on the computer you must tell Windows 95 your name (and the name of the company for which you work, if applicable) and agree to the legal terms and conditions of the Windows 95 Licence Agreement.

Windows 95 then spends a few minutes analysing your computer and configuring itself to take full advantage of your computer's components. Windows 95 also offers you the opportunity to install a printer. However, you do not have to install a printer at this time if you don't want to.

---

### **You only register once**

*All of this only happens the first time you turn on your computer. After that Windows 95 starts normally, except that you may be reminded if you haven't made any back-up diskettes yet.*

---

## Electronic Fingerprinting

---

Electronic Fingerprinting allows you to ‘brand’ your computer by storing personal information in its permanent memory. If you include your name, address and phone number this will aid the police if your computer is stolen.

The Apricot Electronic Fingerprinting program appears every time you start Windows 95 until you have branded the computer. If you don’t brand your computer promptly, someone else might do it before you!

After you have entered your details you are prompted to set a **branding password**. This password will be requested if you ever need to run the Electronic Fingerprinting program again to change the branding information (for example, if you change address).

Optionally, for extra security, you can decide that this same password is requested every time the computer is turned on, or every time the mains power supply is interrupted.

If you forget your branding password, you can use a special **fall-back password** instead. The fall-back password is a 12-digit number that is unique to your computer. It is displayed only once, the first time you set a branding password.

Click the **Help** button in Electronic Fingerprinting for more information.

---

### **Be careful**

*Do not turn off the computer while using the Electronic Fingerprinting program. It might corrupt your computer’s memory.*

---

---

### **Write down the fall-back password**

*The fall-back password is displayed only once. You must make a note of the password immediately, because you will never see it again. There is a page at the end of this manual where you can write it down.*

---



## **Increasing the resolution and colours displayed by your monitor**

---

At first, Windows 95 is configured for a standard monitor setting (640 by 480 pixels in a maximum of 256 different colours) so that Windows 95 is sure to display correctly whatever monitor you have.

However, Mitsubishi Electric's Apricot monitors can do much better than this standard setting. You should therefore change the display setting to get the best performance from your system.

1. Right-click with the mouse while pointing at the background of the Windows 95 desktop, then select **Properties** from the pop-up menu.
2. Click the Settings tab of the Display Properties dialog.
3. You can now select the Display Area (resolution) and Colour Palette (number of colours). We suggest at least 800 by 600 pixels in 256 colours.

---

### **Tips**

*You may have to specify the make and model of your monitor before you can increase the resolution. In this case, click the **Advanced Properties** button on the Settings tab.*

*You can get an even better display by upgrading your computer's video memory from 2 to 4 Mbytes. Ask your Mitsubishi Electric PC supplier for details.*

---

## Infotrade Internet - The Internet service from Mitsubishi Electric

---

By connecting your computer to the phone network, you can use your computer as an answerphone and fax machine. You can also access the Internet, and in particular the World Wide Web (WWW).

To get you started, we have provided the Infotrade Internet service (this offer applies only in the United Kingdom). Infotrade is a subsidiary of Mitsubishi Electric, the makers of your Apricot PC.

Details of the Infotrade Internet offer are given on the promotional leaflet that came with your computer.

Infotrade also offers a variety of personal finance services. These services are entirely optional and separate from the Internet service. To find out more, double-click the **Infotrade Internet Help** icon on the Windows 95 desktop.



---

### Hint

*Although we recommend the Infotrade Internet service, and have made it very easy for Apricot PC users to subscribe to it, there are other possibilities. On the Windows 95 desktop is an icon for **The Microsoft Network**, which is the on-line service provided by Microsoft itself. And in the **On-line Services** folder (also on the desktop) you will find setup programs for other on-line service providers.*

---

## Setting up Infotrade Internet and Fax

---

If you decide to take advantage of the Infotrade Internet offer, you will need the Infotrade Internet leaflet that came with your computer.

---

### Hint

*You should run **Infotrade Internet and Fax Setup** even if you don't want to subscribe to Infotrade Internet, as it also sets up the Microsoft Fax service.*

---

1. Double-click the **Infotrade Internet and Fax Setup** icon on the Windows desktop.



2. Follow the instructions on the screen, together with the information provided on the Infotrade Internet leaflet. When the setup is complete, you are prompted to restart your computer.

Once your computer has restarted, you are ready to connect to the Internet and register your new account with Infotrade.

3. Make sure the modem cable is connected from the back of the computer to your phone socket.
4. Double-click on **The Internet** icon  on the Windows desktop to start Microsoft's Internet Explorer.
5. Follow the instructions on the screen to register with Infotrade.

Once you've finished the registration process, you can either exit from Internet Explorer, or go on to explore or "surf" the World-Wide Web.

---

### In the future

*You only have to register once, but whenever you use Internet Explorer subsequently, you have to log on to the Internet with your Infotrade user name and your Infotrade password.*

---

## Easy Manager

Easy Manager is a collection of software from Mitsubishi Electric, designed to make life easier for new computer users.

In the Windows taskbar is a Mitsubishi Electric symbol. If you click it a pop-up menu appears listing all the elements of Easy Manager.



Use the **Help** option to learn how to use the Easy Manager software.

**Answerphone** answers your incoming telephone calls automatically. Calls may be either voice messages (voice mail) or fax messages.

**Easy Manager Configuration** allows you to say which parts of the Easy Manager collection you want to use.

**Entertainment Centre** offers easy access to a range of games, reference and productivity programs, some of which may be pre-installed on your computer's hard disk or supplied on CD.

**Message Centre** is the place where incoming electronic mail (e-mail), voice and fax messages are available for you to review, and where you can create and send your own outgoing e-mail and fax messages. You can also set up short "reminders" for yourself, family members, and friends who use your computer.

**Power Management** allows you to program the automatic power saving features of your computer.

## The Remote Control

---

The optional infra-red remote control makes your computer easier to use.

It works with all Easy Manager programs, and also with the audio CD Player and Microsoft Internet Explorer.

The remote will only work with TV tuner cards that are approved by Mitsubishi Electric PC Division.

The remote control operates on two AA batteries, which are provided. Insert the batteries as shown on the right.

---

**Hint**

*To find out more about the remote control, click on the Mitsubishi Electric symbol in the Windows taskbar, then click **Help**.*

---

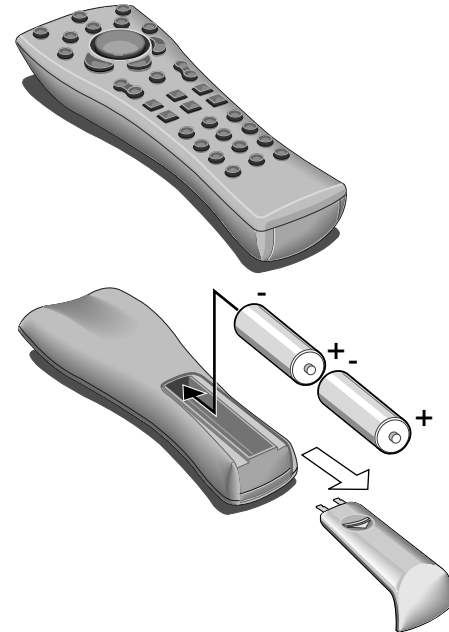

# **APRICOT MS SERIES OWNER'S HANDBOOK**



***DESKTOP (MW) EDITION***

Microsoft, MS-DOS, and Windows are registered trademarks of Microsoft Corporation in the US and other countries.

FireWire and the FIREWIRE logo are trademarks of Apple Computer, Inc., registered in the US and other countries.

Other trademarks mentioned within this document and not listed above are the properties of their respective owners.

Information contained in this document is subject to change without notice and does not represent a commitment on the part of Apricot Computers Limited. Any software described in this manual is furnished under a license agreement. The software may be used or copied only in accordance with the terms of this agreement. It is against the law to copy any disk supplied for any purpose other than the purchaser's personal use.

No part of this manual may be reproduced or transmitted in any form or by any means electronic or mechanical including photocopying and recording, for any purpose, without the express written permission of the publishers.

Copyright © Apricot Computers Limited 1997. All rights reserved.

Published by:  
Apricot Computers Limited  
3500 Parkside  
Birmingham Business Park  
Birmingham, England  
B37 7YS

<http://www.apricot.co.uk>



---

APRICOT MULTIMEDIA PCs

Printed in the United Kingdom

## Safety and Regulatory Notices

---

### Electrical

The computer uses a safety ground and must be earthed.

The system unit AC power cord is its 'disconnect device'. Ensure that the system unit is positioned close to the AC power outlet and that the plug is easily accessible.

The power cord packed with the computer complies with the safety standards applicable in the country in which it is first sold. Use only this power cord. Do not substitute a power cord from any other equipment.

To prevent fire and electric shock, do not expose any part of the computer to rain or moisture. Turn off the computer and unplug all power cords before moving or cleaning the system unit, or removing the system unit top cover.

### Battery

This product contains a lithium battery.

Do not use a metal or other conductive implement to remove the battery. If a short-circuit is made between its positive and negative terminals the battery may explode.

Replace a discharged battery with one of the same type; another type may explode or ignite. Follow the instructions contained in the *Owner's Handbook* to replace the battery.

Dispose of a discharged battery promptly and in accordance with the battery manufacturer's recommended instructions. Do not recharge, disassemble or incinerate the discharged battery. Keep away from children.

### Laser products

Any CD-ROM drive fitted in this system is classified as a CLASS 1 LASER PRODUCT according to IEC825 *Radiation Safety of Laser Products (Equipment Classification: Requirements and User's Guide)*. The CLASS 1 LASER PRODUCT label is located on the underside of the system unit.

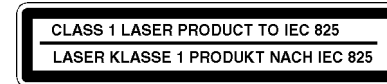

The CD-ROM drive contains a laser system which is harmful to the eyes if exposed. Do not attempt to disassemble the CD-ROM drive; if a fault occurs, call an authorised maintainer.

Use the CD-ROM drive only as described in this manual. Failure to do so may result in exposure to hazardous radiation.

### Ergonomic

When positioning the system unit, monitor and keyboard, take into account any local or national regulations relating to ergonomic requirements.



## SAFETY & REGULATORY NOTICES

### **Anti-static precautions**

Static electricity can cause permanent damage to electronic components. You should be aware of this risk, and take precautions against the discharge of static electricity into the computer.

Anyone can generate static electricity by moving on a chair, brushing against desks or walls, or simply walking across an ordinary carpet. Items handed from one person to another, or being wrapped or unwrapped, can acquire a static charge. Air conditioning systems can also result in ambient static. Clothing made of synthetic fibres is particularly likely to generate static electricity; this static electricity is often completely unnoticed by the wearer, but can be sufficient to cripple or impair an electronic component.

The computer is at risk from static discharge while the top cover is off. This is because the electronic components of the motherboard are exposed. Memory modules, expansion cards and replacement processors are other examples of electrostatic sensitive devices (ESSDs).

All work that involves removing the cover must be done in an area completely free of static electricity. We recommend using a Special Handling Area (SHA) as defined by EN 100015-1: 1992. This means that working surfaces, floor coverings and chairs must be connected to a common earth reference point, and you should wear an earthed wrist strap and anti-static clothing. It is also a good idea to use an ionizer or humidifier to remove static from the air.

When installing any upgrade, be sure you understand what the installation procedure involves before you start. This will enable

you to plan your work, and so minimise the amount of time that sensitive components are exposed.

Do not remove the system unit cover, nor the anti-static bag or wrapping of any upgrade, until you need to.

Handle static-sensitive items with extreme care. Hold expansion cards and add-on components only by their edges, avoiding their electrical contacts. Never touch the components or electrical contacts on the motherboard or on expansion cards. In general, do not handle static-sensitive items unnecessarily.

Keep all conductive material, and food and drink, away from your work area and the open computer.

### **Thermalcote bonding compound**

The thermal bonding compound used between the system processor and its heat sink can cause skin irritation and stain clothing. Avoid prolonged or repeated contact with skin. Wash thoroughly with soap and water after handling. Avoid contact with eyes and inhalation of fumes. Do not ingest.

### **Transporting**

Use common sense when handling the computer; hard disks in particular can be damaged if the computer is dropped or handled roughly. As a precaution, back up the contents of the hard disks to tape or diskettes before moving the computer.

Don't try to move the computer while it is plugged into the AC power supply or with any other cables, including network cables, still attached.

When lifting and carrying the computer, grip the metal underside of the system unit. Never attempt to lift the system unit with a monitor on top.

If you need to transport the computer any great distance, use the original packing materials.

### **Maintenance**

Do not use sprays, solvents or abrasives that might damage the system unit surface. Do not use cleaning fluids or sprays near air vents, ports, or the diskette and CD-ROM drives.

Occasionally wipe the system unit with a soft, slightly damp, lint-free cloth.

Occasionally wipe over the air vents on the rear and sides of the system unit. Dust and fluff can block the vents and limit the airflow.

Occasionally clean the diskette and CD-ROM drives using a proprietary head cleaner.

Occasionally wipe the monitor with a soft, slightly damp, lint-free cloth. It is best to use anti-static glass cleaner on the monitor screen, but do not spray glass cleaner directly onto the screen; it could run down inside the case and damage the circuitry.

## Power Connection

---

### Typical AC plugs

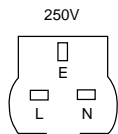

**BS1363A**

U. K.

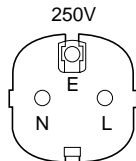

**SHUCO**

Austria Belgium  
Finland France  
Italy Germany  
Sweden Norway  
Holland

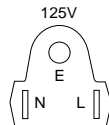

**NEMA 5-15P**

Taiwan  
Thailand  
Japan  
USA  
Canada

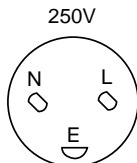

**SRAF 1962/DB16/87**

Denmark

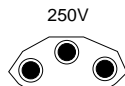

**ASE 1011**

Switzerland

### Checking the AC power supply

When this product is delivered, it is ready for the commercial AC power supply generally available in the country in which it is first sold. It has been set for the correct voltage range, and is supplied with an AC power cord and plug which comply with the relevant safety standards. Before using the product in a country other than that in which it was originally sold, you must check the voltage and frequency of that country's AC power supply, and the type of power cord required there. Check the power rating labels on the rear of the computer's system unit and its monitor to ensure that they are compatible with the AC power supply.

The computer can function within two alternative AC power supply ranges, according to the position of the voltage selection switch on the rear of the system unit:

Switch setting	AC power supply (voltage and frequency)
115	100 - 120 volt AC, 50 - 60 Hz
230	200 - 240 volt AC, 50 - 60 Hz

The voltage setting of the monitor must always be the same as the voltage setting of the system unit. See the *User Guide* that accompanies the monitor or consult your supplier to find out how to change the voltage setting.

It is imperative that the computer is set to the correct voltage range before use. If not, the machine may be irreparably damaged.

### Connecting to the AC power supply

---

#### Important

*Any peripheral equipment that requires an AC power cord must be earthed.*

---

Use the following guidance to connect the components together. It is important that you take each step in the order indicated.

1. Before connecting any components, ensure that the AC power supply is switched off or disconnected, and that the system unit, the monitor, and any peripherals are turned off.
2. Connect the components' signal cables to their respective ports on the system unit: keyboard, mouse, monitor, audio (where appropriate) and any other peripherals. Where appropriate, connect the computer to the network.

3. Connect the components' power cords: monitor to system unit, and system unit and any other peripherals to nearby, grounded AC power outlets. Then switch on or connect the AC power supply.
4. Turn on the system unit first, then the monitor, then other peripherals.

### Power Cable Connections - UK ONLY

This equipment is supplied with an AC power cord that has a non-removable moulded plug.

Always replace the fuse with one of the same type and rating which is BSI or ASTA approved to BS1362. Always refit the fuse cover, never use the plug with the fuse cover omitted.

## Standards

---

### Safety

This product complies with the International safety standard IEC950 and the European safety standard EN60950 which will, when applicable, include the national deviations for the country in which it is first sold.

### Electro-magnetic Compatibility (EMC)

This product complies with the following European EMC standards:

Emissions EN50022 Class B

Immunity EN50082-1

This product also complies with the following International EMC standard:

VCCI Level 1 (Japan)

## SAFETY & REGULATORY NOTICES

### Notes

All interconnecting cables (for example, microphone, headphones or external speakers) and communication cables should be less than 2 metres in length.

If cable extensions are used, ensure adequate earth connections are provided and screened cables are used.

If the system unit top cover, or any other metal part, is removed and then replaced, all parts must be correctly re-assembled and all screws tightened.

### Legalities

---

This equipment complies with the relevant clauses of the following European Directives (and all subsequent amendments):

Low Voltage Directive	73/23/EEC
EMC Directive	89/336/EEC
Telecommunications Directive	91/263/EEC
CE Marking Directive	93/68/EEC

---

### Important

*This system complies with the CE Marking Directive and its strict legal requirements. Use only parts tested and approved by Mitsubishi Electric PC Division. Failure to do so may result in invalidating both the compliance and your warranty. All expansion cards, drives and peripherals must carry the CE mark to ensure continued compliance.*

---

# CONTENTS

## **1 Welcome**

---

Pictorial guide to the system unit.....	1/2
The Remote Control .....	1/8
General advice.....	1/9

## **2 Diskettes and CDs**

---

Diskette drive .....	2/1
CD-ROM drive .....	2/3

## **3 Multimedia**

---

### **4 Expansion Cards**

---

Configuring the card .....	4/2
Installing the card.....	4/5
Reserving ISA legacy resources.....	4/7
Telling Windows about the new hardware.....	4/8

## **5 Motherboard Features & Upgrades**

---

Motherboard jumper settings .....	5/3
Motherboard resource assignments.....	5/5
Adding more memory .....	5/8
Adding more video memory .....	5/11
Upgrading the processor.....	5/12
Replacing the configuration battery.....	5/16

## **6 Hard Disk Upgrades**

---

Configuring the drive .....	6/2
Installing the drive.....	6/3
Partitioning and formatting the drive .....	6/5

## **7 BIOS Setup & POST**

---

BIOS Setup.....	7/2
Power-on self-test .....	7/4

**8 Troubleshooting**

---

Problems when starting ..... 8/2

Common problems ..... 8/4

**Equipment Log**

---

# 1 WELCOME

This first chapter gives you a quick tour of your new Apricot MS Series Personal Computer. It lists the special features of the computer and has pictorial guides to help you identify the various parts.

If you want to get started working with your Apricot PC straight away, unpack and assemble it as shown on the accompanying *Welcome Mat*, then read the *Quick Start Guide* at the front of this manual.

After unpacking your computer, keep all the cartons, boxes and packaging materials; you will need them again if you have to transport the computer elsewhere.

Use the page at the end of this manual to make a note of the manufacturer's data recorded on the various components (product codes, serial numbers, etc.). A service engineer may need this information if the computer develops a fault.

---

### **For your own safety**

*Read the Safety & Regulatory Notices section at the start of this manual before using the computer for the first time.*

---

### **Standard features**

- ◆ Pentium MMX processor
- ◆ At least 16 Mbytes of main memory
- ◆ 512 Kbyte memory cache
- ◆ ATI 3D Rage Pro video system
- ◆ At least 2 Mbytes of video memory
- ◆ CD-ROM drive
- ◆ Sound Blaster Pro-compatible audio system
- ◆ Stereo, line-in and line-out audio sockets
- ◆ MIDI/Joystick port
- ◆ Two USB ports
- ◆ Serial and ECP Parallel ports
- ◆ Stereo speakers (and optional sub-woofer)
- ◆ Easy Manager software

### **Enhanced features (factory options)**

- ◆ FireWire, S-Video and Composite Video ports
- ◆ Wavetable audio enhancement
- ◆ SPDIF digital audio port
- ◆ Infra-red remote control



## Pictorial guide to the system unit

---

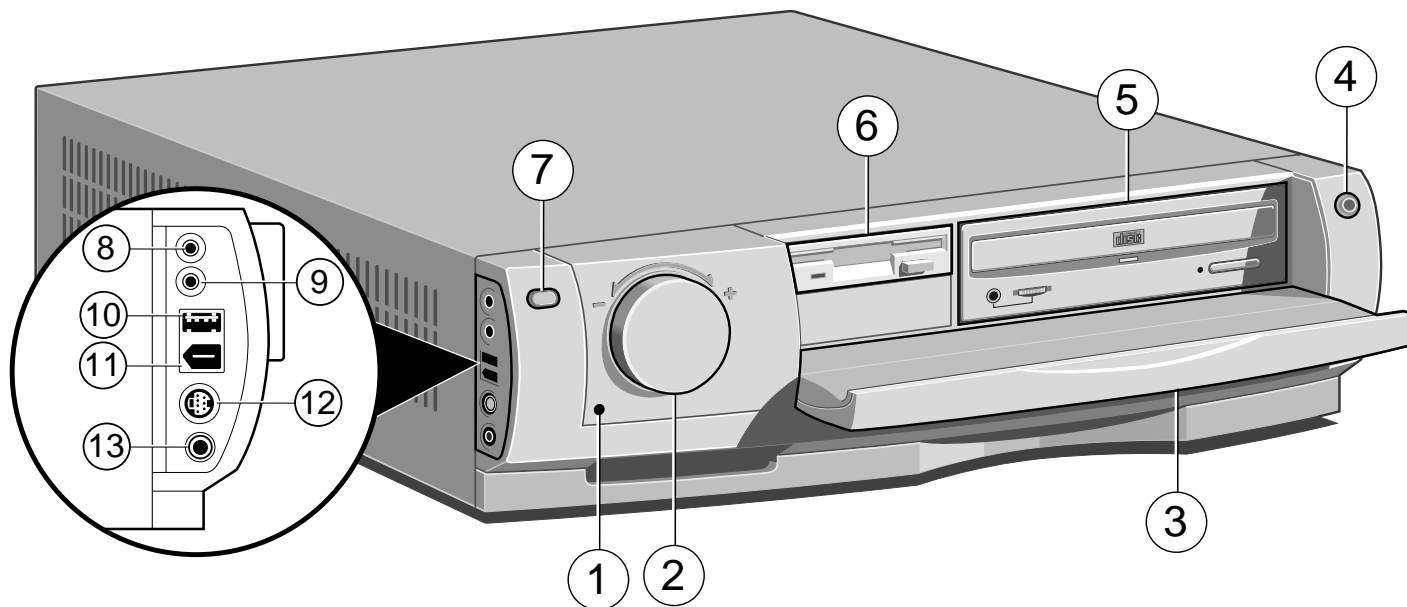

**Key**

- 1 Power Mode light
- 2 POWER button
- 3 Front bezel door
- 4 MESSAGE button (and light)
- 5 CD-ROM
- 6 Diskette drive
- 7 Infra-red sensor
- 8 Line In socket
- 9 Headphones socket
- 10 Universal Serial Bus (USB) port
- 11 FireWire port (factory option)
- 12 S-Video In port (factory option)
- 13 Composite Video In port (factory option)

Press the POWER button to turn the computer on, put it to sleep or wake it up.

Turn the POWER button to increase or decrease the volume of sound through the speakers.

The Power Mode light changes colour to show the current state of the computer.

- ◆ **Off.** [red] Your computer is turned off, but is still connected to the AC power supply.
- ◆ **Suspend.** [yellow] Your computer is “sleeping” to conserve electricity. Briefly pressing the POWER button wakes it up again.
- ◆ **On or Standby.** [green] Your computer is awake and working, but may reduce power during idle moments (Standby mode). Move the mouse or press any keyboard key to activate it again.

See the *Quick Start Guide* for more information.

The light on the MESSAGE button flashes when the Message Centre program (part of the Easy Manager collection) has one or more unread e-mails, faxes or reminders for you. Either read the messages or press the button to extinguish the light.

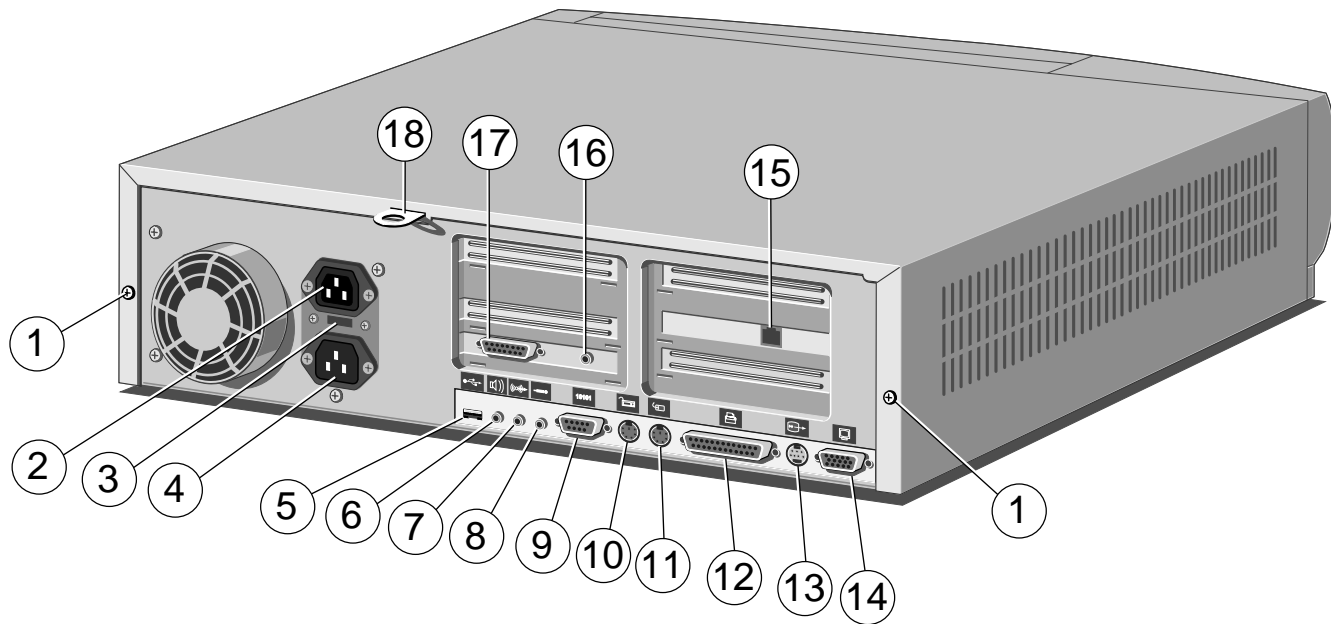

**Key**

- 1 Casing screws for the top cover
- 2 AC power outlet for monitor
- 3 Voltage selection switch
- 4 AC power inlet from AC supply
- 5 Universal Serial Bus (USB) port
- 6 Speaker socket
- 7 Line Out socket
- 8 Microphone socket
- 9 Serial port
- 10 Keyboard port
- 11 Mouse port
- 12 Parallel (printer) port
- 13 TV Out port (factory option)
- 14 Monitor port
- 15 Modem port
- 16 SPDIF digital audio output (factory option)
- 17 MIDI/Joystick port
- 18 Security loop for cable or padlock

For more information about the various audio, video, and multimedia options, see the *Multimedia* chapter.

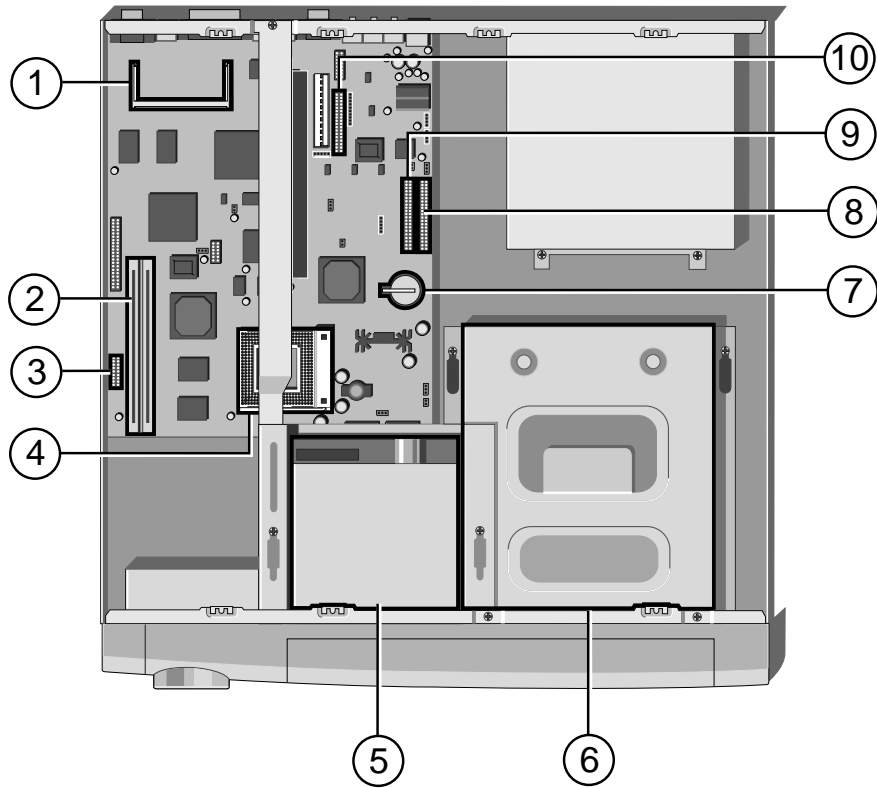

**Key**

- 1 Video memory upgrade socket
- 2 DIMM sockets for system memory upgrades
- 3 Main jumper block
- 4 Processor socket; Zero Insertion Force (ZIF) "Socket 7"-type
- 5 Diskette drive
- 6 Drive assembly for CD-ROM and HDDs
- 7 CMOS battery
- 8 Primary E-IDE interface connector for hard disk drives
- 9 Secondary E-IDE interface connector for the CD-ROM drive
- 10 1.44 Mbyte diskette drive connector

**To remove the system unit cover**

1. Shut down the computer and turn off the monitor.
2. If your AC power outlets have switches, set them to their off positions.
3. Unplug all power cords from the rear of the system unit.
4. Unfasten the two casing screws.
5. Slide the top cover rearwards slightly, then lift it off.

Refitting is the reverse of removal. Take effective anti-static precautions while the top cover is off, as explained in the *Safety & Regulatory Notices* at the start of this manual.

See the chapter on *Motherboard Features & Upgrades* for more information about the motherboard.

## The Remote Control

---

The optional infra-red remote control incorporates a two-button mouse pad, a numeric keypad and several other specialist buttons.

The MENU button displays the Remote Status window (see below) which tells you which program the remote is currently controlling, and allows you to change this if necessary.



---

### Hint

*To find out more about the remote control, click on the Mitsubishi Electric symbol in the Windows taskbar, then click Help.*

---

CD starts the CD program.

STANDBY puts the computer into (or wakes it up from) an energy-saving mode.

MESSAGE starts the Message Centre program.

OK and CANCEL accept and decline changes.

TV starts the TV/Teletext program (works only with TV tuner cards approved by Mitsubishi Electric PC Division).

EXIT closes the current program.

TASK switches between the programs currently running on your PC.



## General advice

---

This computer is designed to be used in a normal home or office environment. Here are a few hints for choosing a suitable site:

- ◆ Place the system unit flat on a sturdy, level surface, free from vibration.
- ◆ Site the computer away from moisture, direct sunlight, and extremes of heat and cold. Avoid situations in which the surrounding temperature or humidity may change rapidly. When the computer is in use, the temperature should be between 10 and 35 °C and humidity between 20% and 80% (with no condensation).
- ◆ When positioning the system unit, monitor and keyboard, take into account any local or national regulations relating to ergonomic requirements. For example, you should ensure that little or no light is reflected off the monitor screen as glare, and that the keyboard is placed in a comfortable position for typing.

- ◆ Give the computer plenty of room so that air can circulate on all sides. Air is drawn into the system unit through vents at the front and on the left-hand side, and expelled through the vent on the back. Ensure that these vents are never obstructed.

Do not allow any cables, particularly power cords, to trail across the floor where people walking past can snag them.

---

### Warning

*The computer uses the system unit AC power cord as its 'disconnect device'. Ensure that the system unit is positioned close to the AC power outlet, and that the plug is easily accessible.*

*To prevent fire and electric shock, do not expose any part of the system unit to rain or moisture.*

---



### **Backing-up the pre-installed software**

Apricot PCs arrive with a pre-installed copy of Windows 95. Additional software may be pre-installed at the factory or by your Mitsubishi Electric PC supplier.

We *strongly* recommend that you copy or 'back-up' any pre-installed software soon after setting up the system. This is particularly important for systems that are supplied without installation diskettes for the software on the hard disk. A back up copy will safeguard the pre-installed software against loss if the hard disk fails or if you accidentally overwrite or delete files.

- ◆ The Microsoft Create System Disks utility allows you to create installation diskettes from disk images pre-installed on the hard disk.
- ◆ To back up other pre-installed software (and your own files) use the Backup tool. Click the **Start** button in the Windows taskbar, then **Programs, Accessories, System Tools** and **Backup**.

In general, any copy you make of pre-installed software must be used only as a back-up copy, in case the pre-installed version is lost. You are **not** allowed to use installation diskettes created from disk images to install the software onto another computer.

## 2 DISKETTES and CDs

### Diskette drive

---

Your Apricot PC is fitted with a 1.44 Mbyte diskette drive. This accepts either 1.44 Mbyte (HD) or 720 Kbyte (DD) diskettes.

Each diskette has a rigid plastic cover, with a metal shutter that guards the disk surface. Never touch the exposed surface under the shutter – you could deform the disk or leave a fingerprint that might make the diskette difficult to read.

Keep diskettes away from dust, moisture, magnetic objects, and equipment that generates magnetic fields. Also, avoid extremes of temperature and exposure to direct sunlight. Otherwise, data recorded on the diskette may become corrupted.

### ***Inserting a diskette***

1. Insert the diskette with the metal shutter foremost, and with the label side facing upwards.
2. Push the diskette all the way in until it 'clicks' into place. The drive's EJECT button pops out slightly. The drive flap stays open, leaving the diskette just visible.

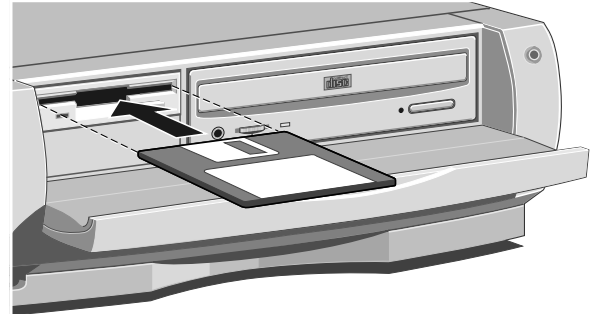

### ***Ejecting a diskette***

- ◆ Wait until the drive's activity indicator is unlit, then press the EJECT button.

If a diskette becomes stuck in the drive, perhaps because its label has peeled back, do not attempt to remove it with tweezers or any similar implement; you risk damaging the drive. Call an authorised maintainer.

### ***Write-protecting a diskette***

- ◆ A diskette can be write-protected by sliding a tab towards the edge of the diskette to expose the small hole beneath it (see illustration). Note that the location of the tab depends on the type of diskette.

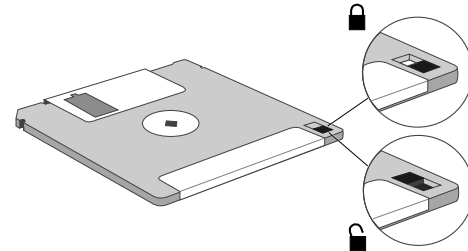

You can read, copy or print the files on a write-protected diskette, but you cannot create, rename or delete any files.

## CD-ROM drive

---

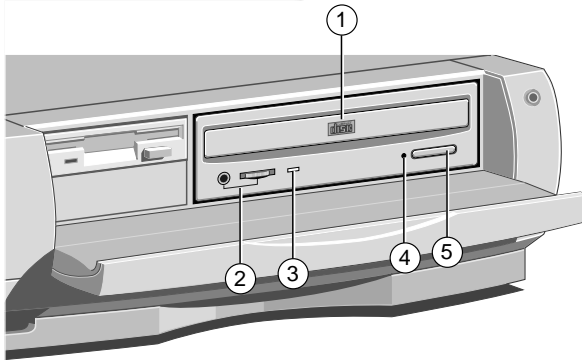

- 1 CD-ROM disc drawer (platter) .
- 2 Headphone jack & volume control.
- 3 Activity indicator (amber = busy).
- 4 CD emergency eject hole.
- 5 EJECT button (doesn't work while PC is turned off).

The CD-ROM drive can retrieve multimedia data from CD-ROM discs and multi-session Photo-CD discs. It can also play normal music CDs (the drive has its own headphone jack and associated volume control).

Keep CDs well away from dust and moisture, and avoid touching the surface of the CD. Avoid extremes of temperature and exposure to direct sunlight as these may cause the disc to warp.

Do not attempt to move the computer while a CD is in the drive, especially if the CD is being played at the time.

---

### **Warning**

*The laser beam inside the CD-ROM drive is harmful to the eyes if looked at directly. Do not attempt to disassemble the CD-ROM drive. If a fault occurs, call an authorised maintainer.*

---

***Inserting a compact disc***

1. Press the EJECT button on the front of drive.
2. Place the CD centrally, printed side up, on the platter.
3. Push the EJECT button again, or gently push the front of the platter to draw it back into the drive.

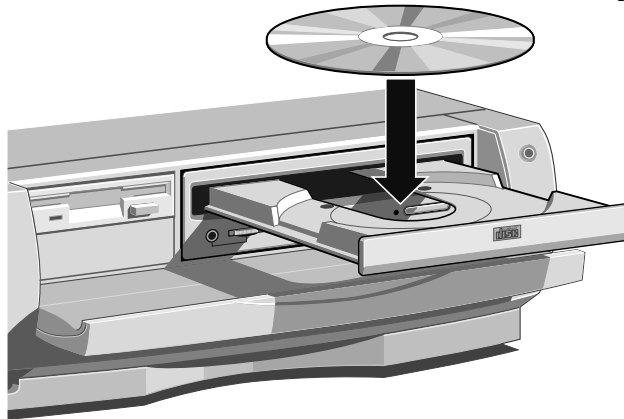

***Ejecting a compact disc***

- ◆ Ensure that the drive's activity indicator is not showing 'busy', then press the EJECT button.

To eject the platter manually (for example, during a power failure) you must first ensure that the computer is completely off (the Power Mode light must be unlit). Insert a thin metal rod, such as an unwound paper clip, into the emergency eject hole. Push carefully and firmly.

## 3 MULTIMEDIA

Your Apricot MS Series computer has sophisticated on-board video and audio systems and a range of ports and sockets for multimedia applications (some available only on enhanced models). With the appropriate software and peripherals, the computer can be used for:

- ◆ 3-D computer games
- ◆ Video conferencing
- ◆ Animated graphics production and editing
- ◆ Digital audio editing and MIDI sequencing
- ◆ Digital video editing (requires a fast second hard disk)

Ports and sockets are located on the front bezel and on the motherboard at the rear of the system unit. Some optional ports are located in the sixth (fake) expansion card slot. See the *Welcome* chapter if you need help identifying these ports and sockets.











---

### Technical summary

*The video system is ATI Technologies' 3D Rage Pro. This accelerates 3-D and motion video, supports Windows Direct3D, and assists DVD/MPEG-2 video decoding. In some models the 3D Rage Pro is augmented by an ATI ImpactV part providing TV output. The video system can be enhanced by fitting an approved MPEG-2 or TV tuner expansion card and interfacing it through the VESA Feature Connector & ATI Media Channel (VFC/AMC).*

*The audio system is a Crystal Semiconductors part which is compatible with Sound Blaster Pro. Depending on the model, it may be enhanced by Sound Retrieval System (SRS) 3-D sound technology and a General MIDI wavetable music synthesiser.*

---

Front		Headphones	Out	Audio	Analog
		Line In	In	Audio	Analog
		S-Video	In	Video	Analog
		Composite Video	In	Video	Analog
		Universal Serial Bus	In/Out	Multimedia	Digital
		FireWire (IEEE 1394)	In/Out	Multimedia	Digital
Rear		Microphone	In	Audio	Analog
		Universal Serial Bus	In/Out	Multimedia	Digital
		Speakers	Out	Audio	Analog
		Line Out	Out	Audio	Analog
		TV Out (S-Video)	Out	Video	Analog
Slot 6		MIDI	In/Out	Multimedia	Digital
		SPDIF	Out	Audio	Digital

**Headphones**

Although this stereo audio socket is intended for headphones it could also be used for output to a personal cassette recorder. When you plug something into this socket, the external speakers are automatically muted.

**Microphone**

This mono audio socket provides phantom power for electret-type microphones.

**Speakers**

Use this socket to connect the external stereo speakers. These speakers may also be used together with the optional DeepSound sub-woofer.

**Line In and Line Out**

These stereo audio line sockets are intended for connecting your PC to analog audio/video equipment such as camcorders, VCRs, hi-fi components and televisions. The front Line In socket could also be used as an alternative to the

rear Microphone socket, or for input from a personal cassette or CD player.

**S-Video and Composite Video**

These front panel inputs allow you to connect your PC to analog video equipment such as cameras, camcorders and VCRs. The S-Video input is for Hi8 or S-VHS devices in which the luminance (brightness) and chrominance (colour) signals are separated for higher fidelity. The Composite Video input is for VHS or Video8 equipment.

**TV Out (S-Video)**

This port is suitable for analog video equipment such as VCRs and televisions. (The corresponding audio signal, if any, is available by the rear Line Out socket.)

**SPDIF**

SPDIF (Sony/Philips Digital Interface) is the consumer version of the AES/EBU digital audio interface standard used for the professional recording and mastering of media such as CDs and DAT tapes.



### **MIDI**

The Musical Instrument Digital Interface is a standard way of connecting musical instruments, synthesisers, computers and other devices. More than merely digitised sound, MIDI encoding provides a complete musical description of a composition and its performance. To connect your computer to other MIDI devices, you'll need a port adapter to provide separate MIDI In and MIDI Out ports. A MIDI adapter can be obtained from most good music equipment stores. A MIDI sequencer program is required to record, save and edit MIDI files.

### **Universal Serial Bus**

The USB is a new way of connecting peripherals to your computer. It has several advantages over existing serial and parallel ports. If necessary, several USB devices can be "daisy-chained" together. USB devices are "hot-pluggable"; that is, they can be plugged in and disconnected without turning off the computer. The USB can supply DC power to certain devices, so that they do not need an independent power supply. It is also quite fast,

operating at 12 megabits per second, which is appropriate for a wide range of applications including video conferencing cameras. The Apricot MS Series has one USB port on the front bezel and another on the rear of the system unit.

### **FireWire**

FireWire (more formally, IEEE 1394) is a new way of connecting devices such as Digital Video (DV) camcorders, VCRs and DVD players to your PC. It can also be used for colour printers, film scanners, or indeed any device that requires the very fast transfer of digital information. Like USB, FireWire devices are hot-pluggable and can be daisy-chained together. However, FireWire is much faster than USB – up to 400 megabits per second. Apricot MS Series computers equipped with FireWire have one port on the front bezel and one or two ports at the back, provided by an expansion card.

## 4 EXPANSION CARDS

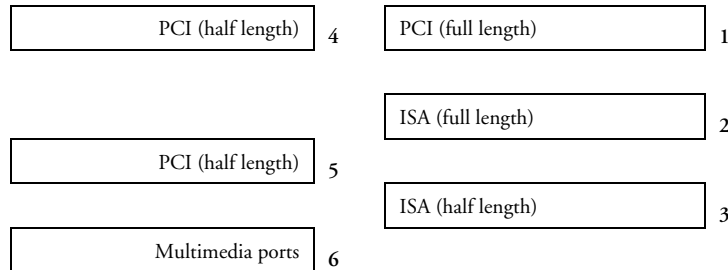

*This diagram shows the layout of the five expansion slots in your PC (as viewed from the rear). Slot 2 is usually occupied by a factory-fitted modem. The sixth "slot" is reserved for multimedia ports.*

---

### Important

*This system complies with the CE Marking Directive and its strict legal requirements. Use only parts tested and approved by Mitsubishi Electric PC Division. Failure to do so may result in invalidating both the compliance and your warranty. All expansion cards, drives and peripherals must carry the CE mark to ensure continued compliance.*

---

Expansion cards (also known as expansion boards, controllers or adapters) are small self-contained circuit boards which extend the capabilities of the computer. For example, an MPEG-2 or TV tuner card could enhance the on-board video system.

Your computer can accept two basic types of expansion card:

- ◆ ISA or Industry Standard Architecture cards
- ◆ PCI or Peripheral Component Interconnect cards

You don't need to understand what these terms mean, but before adding a card to your computer you will need to know whether it is ISA or PCI and possibly its physical dimensions.

## **Configuring the card**

---

Part of the installation procedure for an expansion card involves setting up or “configuring” the card so it will work correctly in the computer.

Most modern PCI cards employ a feature called “Plug and Play” (PnP). This allows Windows 95 – and other PnP-aware operating systems – to configure the card automatically the first time you turn on the computer after installing the card.

However, many ISA cards (and some PCI cards) require manual configuration. If manual configuration is required, you will probably need to specify at least two of the following:

- ◆ Interrupt request level (IRQ)
- ◆ Direct memory access (DMA) channel
- ◆ Base input/output (I/O) port address
- ◆ Base memory address

The important thing to understand is that the settings of the card you are installing must not conflict with the settings used by other cards already in the computer or by components on the computer's motherboard.

The documentation accompanying the card should tell you whether the card supports Plug and Play, or if not, how to configure it. Remember to check any diskettes supplied with the card for README or other help files.

Some cards require you to move jumpers or set switches on the card to configure them. This is best done before installing the card in the computer. Other cards can be configured by running a configuration program after installing the card. Some cards use a mixture of both methods.

Cards often come with pre-configured or default settings. It is best to rely on these settings as much as possible, and change them only if they conflict with other devices.

**ISA Interrupt request level (IRQ)**

The “interrupt request level” or “IRQ” is the means by which the expansion card sends a signal to get the attention of, or interrupt, the processor. Your PC has interrupt levels numbered IRQ0 to IRQ15, many of which are needed for components on the computer’s motherboard. There are two ways round this.

- ◆ Many motherboard components are Plug and Play (PnP) devices. If you use BIOS Setup or Windows Control Panel to exclude or reserve an interrupt that is usually assigned to one of these devices, an alternative interrupt will be assigned through Plug and Play and the original interrupt can instead be used by the expansion card.
- ◆ You can disable some motherboard components either by means of the BIOS Setup utility or else by changing jumper settings on the motherboard. This frees the resources used by those components.

See the *BIOS Setup & POST* chapter for more information about BIOS Setup. See the *Motherboard Features & Upgrades* chapter for more information about jumper settings and the usual assignment of interrupts to motherboard components.

**Direct memory access (DMA) channel**

Some hardware devices can use a “DMA channel” to access system memory without directly burdening the processor. Your PC has DMA channels numbered DMA0 to DMA7. As with interrupts, you can use vacant channels or re-assign existing ones.

See the *Motherboard Features & Upgrades* chapter for more information about the usual assignment of DMA channels.

**Base input/output (I/O) port address**

I/O ports are used by the processor to communicate with hardware devices. Each port appears to the processor as an address low down in its address space. Some expansion cards are also controlled by I/O ports. The “base I/O port address” specifies where the card’s ports begin.

### **Base memory address**

Some expansion cards are fitted with memory of their own, usually read-only memory (ROM) containing functional extensions to the computer's BIOS (basic input/output system) ROM. Some cards also have random-access memory (RAM).

In order that this memory can be recognised by the system processor, it must be mapped somewhere within the computer's own address space. By setting the "base memory address" you specify where the card's memory begins within the address space. Typically, an expansion card's memory must be mapped onto the addresses between C8000h and DFFFFh – an area known as the upper memory block or UMB. You can exclude or reserve UMB regions with the BIOS Setup utility.

The card's documentation should list its possible base memory addresses. You may also need to know how much memory the card has, so that you can leave the right gap between this card's base address and the next.

### **More about memory addresses**

Memory *addresses* are always written in base 16 or "hexadecimal" notation. Unlike the ten digits of the decimal system (0-9), hexadecimal uses sixteen digits (0-9 and A-F, where A=10, B=11, C=12 and so on up to F=15).

Hexadecimal numbers are denoted either by the suffix "h" or by the prefix "0x". The final digit of a five-digit memory address is often omitted, so C8000h may be written as C800h.

Because *amounts* of memory are usually stated as kilobytes (Kbytes) rather than in hexadecimal notation, the following conversion table may be helpful:

4 Kbytes = 1000h	32 Kbytes = 8000h
8 Kbytes = 2000h	64 Kbytes = 10000h
16 Kbytes = 4000h	128 Kbytes = 20000h

## Installing the card

Read all these instructions through before attempting to install any expansion card.

### Warning

*Never carry out any work inside the computer with AC power applied. Always shut down the computer and unplug all power cords before removing the top cover.*

The only tool required is a small cross-head screwdriver.

1. Turn off the computer and unplug all power cords.
2. Take suitable anti-static precautions and remove the system unit cover. For more information see “Anti-static precautions” in the *Safety & Regulatory Notices* at the start of this manual.
3. Decide in which of the available slots you wish to install the card, according to its type and size. In general it is easiest, where possible, to start with the lowest slot and work upwards.
- 4a. If the chosen slot is on the left-hand side of the system unit (when viewed from the front) remove its blanking plate by removing the securing screw. Keep the screw; it will be needed later to secure the card.
- 4b. If the chosen slot is on the right-hand side of the system unit (nearer the power supply) remove the plate with the security loop – labelled (A) in the illustration below – then remove the slot's blanking plate.

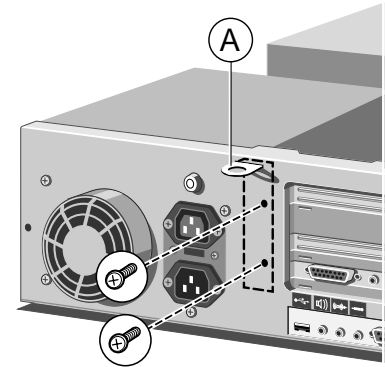

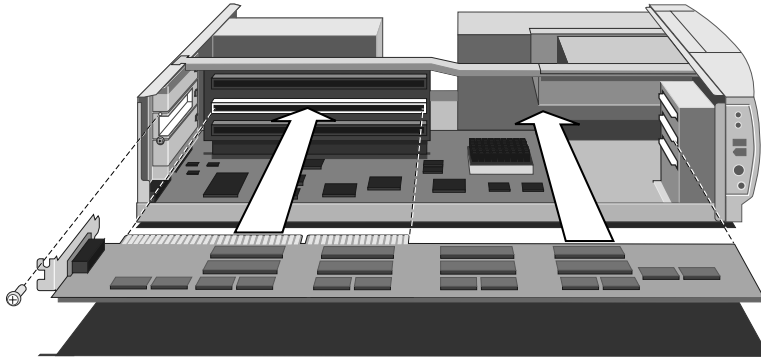

5. If the card you are installing is configured by the means of jumpers or switches, check that it is correctly configured before proceeding.
6. When installing a card that uses the VFC/AMC video feature connector on the motherboard, it is best to plug the video feature cable into the motherboard before you install the card; otherwise, the card may get in the way of the connector. See the *Motherboard Features & Upgrades* chapter to locate the VFC/AMC connector.

---

**Caution**

*Be careful how you use the AMC connector. Some pins carry +5 V power which could damage the expansion card if it is incorrectly attached.*

---

7. Position the expansion card alongside the slot in which you wish to install it. Align the rear of the card with the slot in the rear of the system unit, and, if the card is full length, align the front of the card with the card guide.
8. Slide the card into the slot ensuring that the card edge connector engages correctly with the socket on the riser board. Do not use excessive force.
9. Secure the card by replacing the screw or the security loop panel that you removed in Step 4.
10. Connect any necessary signal cables to the card.
11. Ensure no other cables or connectors have become dislodged, then replace the system unit cover.

## Reserving ISA legacy resources

---

If the computer does not automatically detect the new expansion card the first time you turn it on, start the BIOS Setup utility, go to the Advanced menu and change the Reset Configuration Data item to “Yes”.

If you have just installed an ISA card, you may also want to reserve or exclude the legacy resources (that is, the interrupts and UMB regions) used by the card. This is necessary so that any Plug and Play components can be configured automatically and won't try to use the same settings. See the *BIOS Setup & POST* chapter for more information.

Alternatively, you can use the Windows Control Panel to change the resource settings used by devices:

1. Click the **Start** button in the taskbar, then **Settings**, then **Control Panel**.
2. Double-click on **System**, then click the Device Manager tab of the System Properties dialog.
3. Select the device whose resources you want to change, then click **Properties**.
4. Click the Resources tab of the device's Properties dialog.  
  
If your device does not have a Resources tab, either you cannot change its resources or it isn't using any resource settings.
5. Click the resource you want to change, uncheck the **Use Automatic Settings** box, then click **Change Setting**.

---

### Tip

*In some cases, you may see a **Set Configuration Manually** button on the Resources tab. You may have to click this button before you can change resource settings.*

---



## **Telling Windows about the new hardware**

---

Windows 95 and Windows NT 4.x (or later) should automatically detect and configure cards that support “Plug and Play”. In other cases you may have to tell Windows that you have installed new hardware, as follows:

1. Click the **Start** button in the taskbar, then **Settings**, then **Control Panel**.
2. Double-click on **Add New Hardware**.
3. Follow the instructions in the **Add New Hardware Wizard**.

## 5 MOTHERBOARD FEATURES AND UPGRADES

This chapter describes the features of the computer motherboard and gives step-by-step instructions for adding more system or video memory, upgrading the processor, and replacing the configuration battery. Details of all relevant motherboard connectors and jumper settings are included.

The *Welcome* chapter tells you how to remove the system unit cover. See the section on “Anti-static precautions” in the *Safety & Regulatory Notices* at the beginning of this manual for advice on how to avoid damaging your computer with static electricity.

---

**Warning**

*Never carry out any work inside the computer with AC power applied. Always shut down the computer and unplug all power cords before removing the top cover.*

---

**Do not change jumper settings unnecessarily**

*Do not alter any jumpers or switch settings other than those identified in this chapter, unless told to by your Mitsubishi Electric PC supplier or an authorised maintainer. Otherwise, you may damage the system processor, the motherboard, or both.*

---

**Note**

*After you have upgraded your computer, it may not at first recognise the new configuration. Start the BIOS Setup utility, go to the Advanced menu and change the Reset Configuration Data item to “Yes”, then restart the computer.*

---

# OWNER'S HANDBOOK

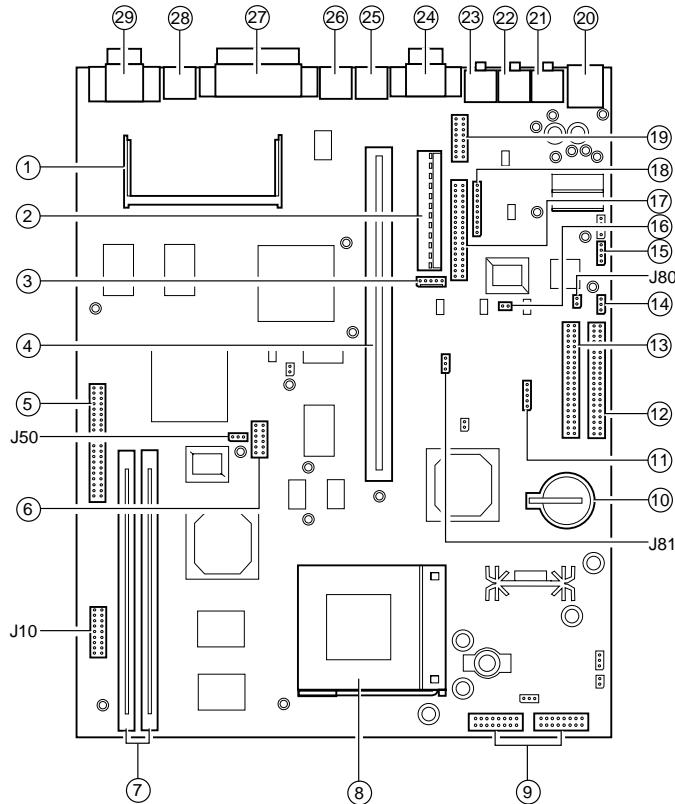

- 1 Video memory upgrade socket
- 2 Motherboard power connector
- 3 PSU logic connector
- 4 Riser board connector
- 5 VFC/AMC video feature connector
- 6 TV tuner/MPEG-2 card connector
- 7 DIMM sockets
- 8 Processor ZIF socket
- 9 Front panel connectors
- 10 CMOS battery
- 11 Front panel USB internal connector
- 12 Primary E-IDE connector
- 13 Secondary E-IDE connector
- 14 "Wake on Call" modem connector
- 15 CD audio connector
- 16 SPDIF internal connector
- 17 1.44 Mbyte diskette drive connector
- 18 Speakerphone modem audio connector
- 19 Joystick/MIDI internal connector
- 20 Universal Serial Bus (USB) port
- 21 Speaker socket
- 22 Line Out socket
- 23 Microphone socket
- 24 Serial port
- 25 Keyboard port
- 26 Mouse port
- 27 Parallel (printer) port
- 28 TV Out (S-Video) port (factory option)
- 29 Monitor port

## Motherboard jumper settings

---

There are only a few jumpers on the motherboard that you may need to alter. All others are set at the factory and should not be changed.

On the motherboard, pin 1 of each jumper block is indicated by a small triangular marking.

---

### Do not change jumper settings unnecessarily

*Do not alter any jumpers or switch settings other than those identified in this chapter, unless told to by your Mitsubishi Electric PC supplier or an authorised maintainer. Otherwise, you may damage the system processor, the motherboard, or both.*

---

### Processor bus speed (J10)

After upgrading your processor, but before turning on the system, you need to change some jumper settings in jumper block J10 to match the speed (in megahertz) of the new processor.

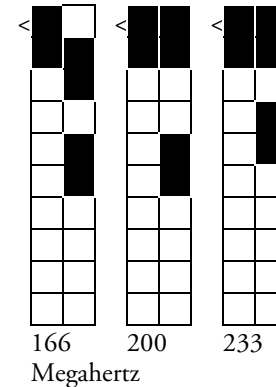

### **On-board video disabling (J50)**

If you install a video adapter expansion card, the computer should automatically detect this and disable the on-board video adapter. If for some reason this does not happen, and you experience problems with a newly-fitted card, you can manually disable the on-board video adapter by moving the jumper in block J50 to pins 2-3.

### **Audio disabling (J80)**

The on-board audio codec can be disabled by moving the jumpers on jumper block J80 to pins 2-3. Disabling the audio system frees the interrupts and DMA channels used by that system (normally IRQ5, IRQ11, DMA0 and DMA1).

## Motherboard IRQs, DMA channels and I/O port addresses

Components	Interrupts (IRQs)															
	0	1	2	3	4	5	6	7	8	9	10	11	12	13	14	15
System timer	■															
Keyboard controller		■														
PIC daisy chain			■													
Infra-red remote control	BS			■												
Serial port 1	BS			■	■	■	■	■		■	■	■	■			■
Audio	JS					■		■		■		■	■			■
Diskette controller	BS						■									
Parallel port (usually sharable)	BS					■		■								
Real time clock									■							
On-board video (sharable)	JS			■	■	■	■	■		■	■	■	■			
USB (sharable)	BS			■	■	■	■			■	■	■	■			
Mouse													■			
Co-processor														■		
Primary E-IDE	BS														■	
Secondary E-IDE	BS															■

*Refer to next page for an explanation of this table.*

Components		DMA channels							
		0	1	2	3	4	5	6	7
Audio	JS	■	■		■				
Diskette controller	BS			■					
Parallel port (in ECP mode)	BS		■		■				
DMAC daisy chain						■			

**Key**



Fixed assignment

BS = Can be disabled by BIOS Setup



Usual assignment

JS = Can be disabled by changing a motherboard jumper setting



Alternative assignment by BIOS Setup



Alternative assignment by Plug-and-Play

## Base Input/Output (I/O) port addresses

The following table lists addresses used by components on the motherboard. Any ports between 100h and 3FFh that are not listed may be used by an expansion card.

### Assigned I/O ports

---

000h-00Fh	0A0h-0A1h	278h-27Bh
020h-021h	0B2h-0B3h	2F8h-2FFh
040h-043h	0C0h-0DEh	330h-331h
048h-04Bh	0F0h	376h-37Fh
060h-061h	15Ch-15Dh	388h-38Bh
064h	170h-177h	3BCh-3BFh
070h-071h	1F0h-1F7h	3E8h-3FFh
076h-07Eh	200h-207h	CF8h-CFFh
080h-08Fh	220h-22Fh	



## Adding more memory

---

You can give your PC more memory by adding or replacing memory modules called “DIMMs”.

The motherboard’s two DIMM sockets accept DIMMs of up to 128 Mbytes in any combination (giving a maximum memory capacity of 256 Mbytes).

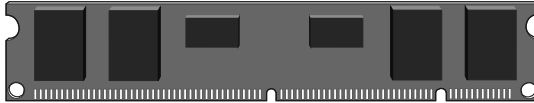

*This is a DIMM (Dual In-line Memory Module).*

---

### Technical note

*The DIMMs you use must have the following specification: gold contacts, 3.3V, 64-bit, unbuffered, SDRAM-type with Serial Presence Detect (SPD) and a CAS latency of 2 at 66 MHz. If you use any other type of DIMM you risk damaging the motherboard.*

---

### Before you begin

1. Turn off the computer and unplug all power cords.
2. Take suitable anti-static precautions and remove the system unit cover. For more information see the section on “Anti-static precautions” in the *Safety & Regulatory Notices* at the start of this manual.
3. Remove any expansion cards that impede access to the DIMM sockets.

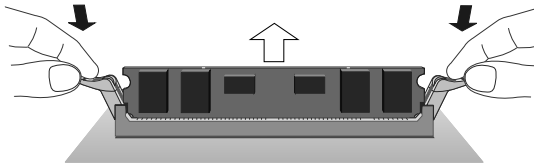

*If you have this type of socket, press the tabs on both of the socket's end clips at the same time. This releases the DIMM and lifts it partly out of the socket.*

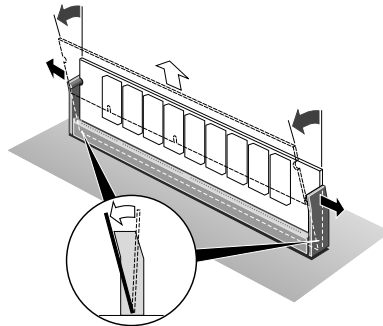

*If you have this type of socket, carefully ease apart the clips at each end to free the DIMM. The DIMM can then be tilted forward and lifted out of the socket.*

## Removing a DIMM

If you need to start by removing a DIMM, follow the diagrams on the left, depending on what type of socket you have.

Hold the DIMM by its ends and avoid touching the metal contacts. Place the DIMM in suitable anti-static packaging.

## Inserting a DIMM

When you take the DIMM out of its anti-static packaging, hold it by its ends and avoid touching the metal contacts.

Follow the diagrams on the right to insert the DIMM, depending on what type of socket you have.

In either case, there are asymmetrical indents along the connector edge that prevent the DIMM being fitted into the socket the wrong way round.

Do not use excessive force. If the module will not fit easily, remove it and start again.

When you have finished, replace any expansion cards you needed to remove, then refit the system unit cover.

If the computer does not automatically detect the new memory the first time you turn it on, start the BIOS Setup utility, go to the Advanced menu and change the Reset Configuration Data item to “Yes”, then restart the computer.

If an error message appears, check that the DIMMs are of the correct type and are seated correctly in their sockets.

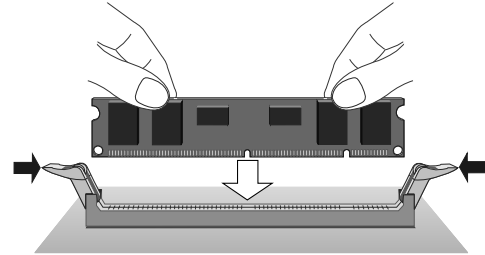

*If you have this type of socket, the DIMM is inserted vertically and held in place by the clips at each end.*

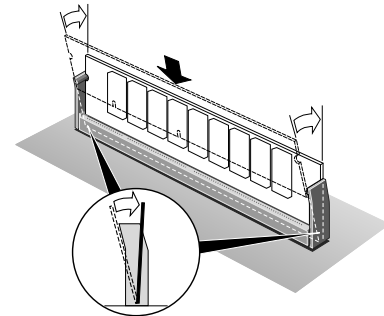

*If you have this type of socket, the DIMM is inserted at a slight angle then leant back in the socket until it clips into place.*

## Adding more video memory

---

Video memory is memory reserved for use by the on-board video controller. More video memory can provide more colours or higher resolutions to an extent determined by the capabilities of your monitor.

If your computer has 2 Mbyte of video memory, you can upgrade it to the maximum of 4 Mbytes by adding a SODIMM (Small Outline DIMM) module.

1. Turn off the computer and unplug all power cords.
2. Take suitable anti-static precautions and remove the system unit cover. For more information see the “Anti-static precautions” section in the *Safety & Regulatory Notices* at the start of this manual.
3. Remove any expansion cards that impede access to the video memory upgrade socket (see the diagram at the start of this chapter).
4. Unpack the upgrade kit. Hold the SODIMM chip by its edges and be careful not to touch the metal pins.
5. Insert the SODIMM into the socket as shown below.
6. Replace any expansion cards you removed earlier and refit the system unit cover.

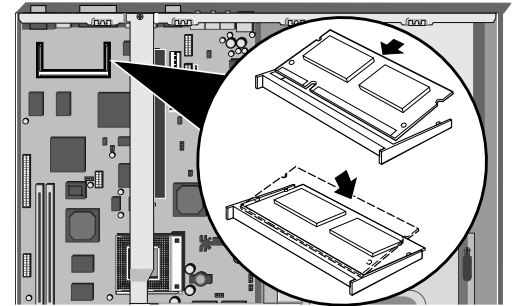

If the computer does not automatically detect the new memory the first time you turn it on, start the BIOS Setup utility, go to the Advanced menu and change the Reset Configuration Data item to “Yes”, then restart the computer.

You can then reconfigure your operating system to use the expanded capabilities of the video controller.

## **Upgrading the processor**

---

The ZIF (zero insertion force) “Socket 7” processor socket on the motherboard is designed to accept a variety of Pentium/MMX processors. You may wish to upgrade your processor by replacing it with one of higher performance.

Read the instructions carefully before starting work.

1. Turn off the computer and unplug all power cords.
2. Take suitable anti-static precautions and remove the system unit cover. For more information see the “Anti-static precautions” section in the *Safety & Regulatory Notices* at the start of this manual.
3. Remove any expansion cards that impede access to the processor.
4. If the system was in use immediately before starting this procedure, the processor will be hot; wait at least 15 minutes for it to cool down.

---

### **Be careful!**

*The processor, its fan-sink (combined fan and heat sink), and some of its neighbouring components can get very hot. You may burn your fingers if you attempt to remove the processor before it has cooled down.*

---

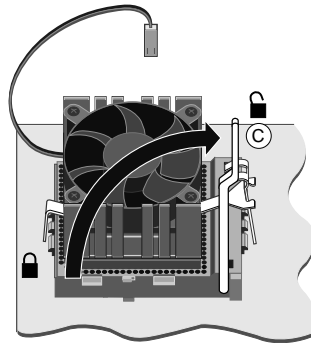
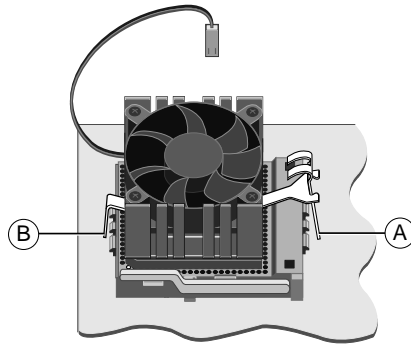

5. Unplug the power cable of the processor's fan-sink from the motherboard. Note where the cable plugs in because you will need to re-attach it later.
6. Press down on the fan-sink's retention clip to release it (A) then unhook the clip from the other side of the ZIF socket (B).
7. Release the lever (C) from the side of the ZIF socket and raise it to the upright position, at right-angles to the motherboard.

There may be a little stiffness at the beginning and end of the lever's movement; be careful not to use excessive force.

8. Lift the processor (with fan-sink) clear of the system unit and place it on an anti-static surface. Hold the processor by its edges and avoid touching any of the metal pins.
9. Separate the fan-sink from the processor by twisting the fan-sink from side to side to loosen the grip of the thermal bonding compound, then slide the fan-sink off to one side of the processor.

---

**Warning**

*When you remove the fan-sink there will be a residual deposit of thermal bonding compound on the bottom of the fan-sink and the top of the processor. This compound can cause skin irritation and stain clothing. Avoid prolonged or repeated contact with skin. Wash your hands thoroughly with soap and water after handling. Avoid contact with eyes and inhalation of fumes. Do not ingest.*

---

10. Ensure that the securing lever on the ZIF socket is still in the upright position.
11. Take the upgrade processor out of its anti-static packaging. Hold the processor by its edges and avoid touching the metal pins.

The upgrade processor (A) and the ZIF socket (B) are keyed to ensure that the processor is installed in the correct orientation. The pin pattern is totally different at one corner. The processor will only fit into the socket one way.

12. Place the processor in the socket, making sure that it is correctly aligned and that you do not bend or otherwise damage the pins.

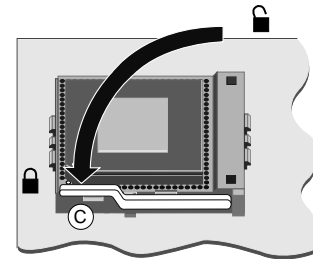
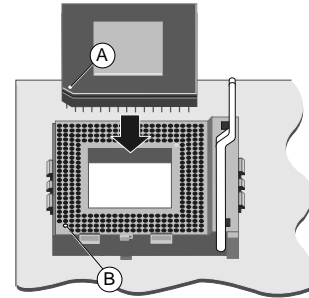

---

**Caution**

*If the processor is misaligned it will not go into the socket, and any attempt to force it will damage the processor, the socket or both.*

---

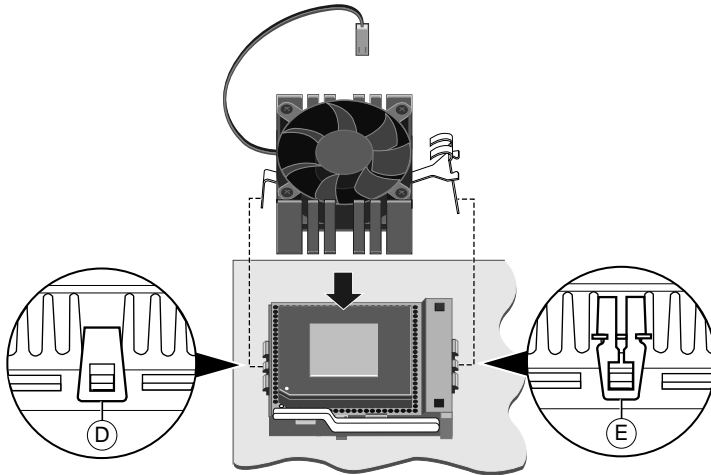

13. Lower the securing lever (C) to the locked position. Apply just enough pressure to overcome the resistance offered by the lever.
14. Put the fan-sink on top of the new processor, and refasten the fan-sink's retention clip to the front (D) and back (E) of the socket.

15. Reconnect the fan-sink's power cable to the motherboard.

---

**Caution**

*If the fan-sink power cable is not reconnected properly, the processor may run slowly or not at all, and there is a risk that it may overheat and be permanently damaged.*

---

16. Adjust the processor bus speed selection jumpers in block **J10** as described at the start of this chapter.

When you have finished, replace any expansion cards you needed to remove, then refit the system unit cover.

If the computer does not automatically detect the new processor the first time you turn it on, start the BIOS Setup utility, go to the Advanced menu and change the Reset Configuration Data item to "Yes", then restart the computer.



## Replacing the configuration battery

---

The computer keeps a record of its current hardware configuration in a CMOS memory chip which is sustained by a small battery. This battery has a life of up to 5 years. If you find that you have to reconfigure the computer every time you turn it on, the battery is probably failing and needs to be replaced.

The battery is a 3 volt lithium type (CR2032 or equivalent) typically used in calculators and other small, battery-powered electronic items.

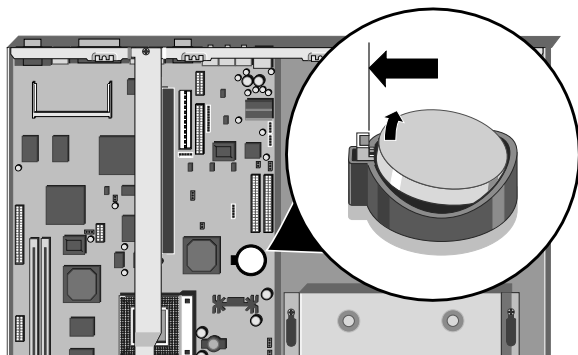

### To replace the battery

1. Turn off the computer and unplug all power cords.
2. Take suitable anti-static precautions and remove the system unit cover. For more information see the section on “Anti-static precautions” in the *Safety & Regulatory Notices* at the start of this manual.
3. Remove any expansion cards that impede access to the battery holder.
4. Using a non-conductive implement, release the latch that holds the battery in place. The battery will pop up allowing you to lift it out of the holder.

---

### **Danger!**

*You must not use a metal or other conductive implement to remove the battery. If a short-circuit is accidentally made between the battery's positive and negative terminals, the battery may explode.*

---

5. Check that the replacement battery looks the same as the battery you have removed.
6. Taking care not to touch the top or bottom surface of the battery, pick up the replacement with the positive (+) terminal upwards. Press the battery into the holder using a non-conductive implement.
7. Replace any expansion cards you removed earlier and refit the system unit cover.
8. Dispose of the discharged battery in accordance with the battery manufacturer's instructions.

The next time you turn on the computer you will have to run the BIOS Setup utility to reset the hardware configuration.

## 6 HARD DISK UPGRADES

This chapter describes how to add a second hard disk to your computer.

---

**Warning**

*Never carry out any work inside the computer with AC power applied. Always shut down the computer and unplug all power cords before removing the top cover.*

---

**Important**

*This system complies with the CE Marking Directive and its strict legal requirements. Use only parts tested and approved by Mitsubishi Electric PC Division. Failure to do so may result in invalidating both the compliance and your warranty. All expansion cards, drives and peripherals must carry the CE mark to ensure continued compliance.*

---

**Note**

*After you have upgraded your computer, it may not at first recognise the new configuration. Start the BIOS Setup utility, go to the Advanced menu and change the Reset Configuration Data item to "Yes", then restart the computer.*

---

## Configuring the drive

---

Your computer can accommodate two E-IDE hard disk drives, known as the master and slave drives. The first drive, which contains the operating system, is always configured as the master. The second drive must be configured as the slave.

Hard disk drives are normally configured as master or slave by using jumpers on the drive itself. Configuration details vary from drive to drive. Most drives are supplied with documentation describing how to configure the drive. If you are uncertain about configuring the drive consult your supplier.

---

### Example

*The example 5.25-inch drive shown below is configured as master or slave by the position of a jumper on the rear of the drive.*

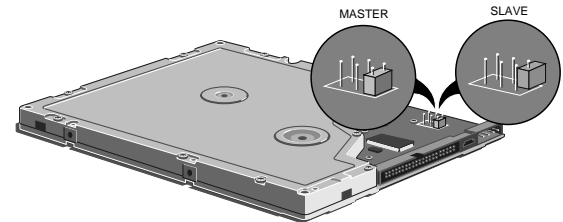

## Installing the drive

---

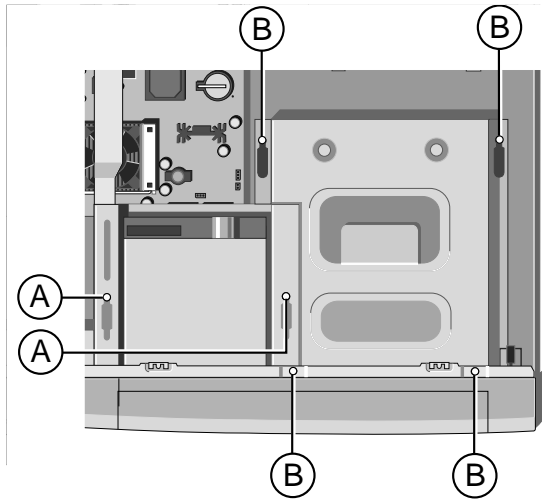

1. Turn off the computer and unplug all power cords.
2. If there is a diskette in the diskette drive, remove it.
3. Take suitable anti-static precautions and remove the system unit cover. For more information see “Anti-static precautions” in the *Safety & Regulatory Notices* at the start of this manual.
4. Disconnect the power and signal (ribbon) cables from the rear of the diskette drive. Take careful note of how they are fitted.
5. Loosen the two screws labelled (A) in the diagram. Slide the diskette drive assembly towards the rear of the system and lift it out.
6. Disconnect the power, signal and CD audio cables from the rear of the CD-ROM drive. Disconnect the power and signal cables from the rear of the existing (master) hard disk drive (HDD). Take careful note of how and where they are fitted.

7. Loosen the four screws labelled (B) in the diagram. Slide the drive assembly towards the rear of the system and lift it out.
8. Fit the new (slave) hard drive into the drive assembly *using the special screws provided* (see below). Try not to touch any drive's electronics.

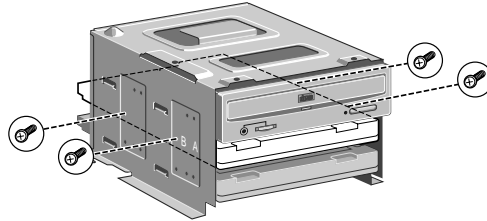

9. Put the drive assembly back into the system unit and tighten the (B) screws to secure it to the chassis.
10. Re-attach the HDD signal cable to the master and slave drives. (Note that the HDD signal cable has two connectors on it; one for the master drive and one for the slave drive.)

11. Attach a spare power cable to the slave drive, and another to the master drive. (It does not matter greatly which of the available power cables you choose.)
12. Re-attach the CD-ROM power, signal and CD audio cables.
13. Put the diskette drive assembly back into the system unit and tighten the (A) screws to secure it. Re-attach the diskette drive power and signal cables.
14. Check to ensure that no other cables or connections have become dislodged or trapped during the work, then replace the system unit cover.

---

**Do you have a 3.5-inch drive?**

*Apricot MS Series computers usually use 5.25-inch hard disk drives. If you have a 3.5-inch drive you will need a special adapter plate to mount it in the drive assembly. Ask your Mitsubishi Electric PC supplier for details.*

---

## Partitioning and formatting the drive

---

If the computer does not automatically detect the new drive the first time you turn it on, start the BIOS Setup utility, go to the Advanced menu and change the Reset Configuration Data item to “Yes”, then restart the computer.

The new drive will initially be blank. Before you can use the drive, you must partition and format it.

With Windows 95, you use the MS-DOS **Fdisk** program to create partitions on the disk. The **Fdisk** program can be run in an MS-DOS window within Windows. Type **Help Fdisk** at the MS-DOS command prompt to find out more. After using **Fdisk**, you are prompted to restart the computer. Once back in Windows, you can format the partitions by opening the My Computer folder, selecting the new Drive icon and choosing the **Format** command from the File menu.

---

### Caution

*When you run **Fdisk**, it assumes that you want to work with the first, or master, drive (it says the Current fixed disk drive is 1). To switch attention to the slave drive, choose Select next fixed disk drive (option 5) from the main menu.*

---

## 7 BIOS SETUP & POST

BIOS (pronounced “bye-oss”) stands for ‘basic input/output system’. The BIOS mediates between the computer’s hardware – the processor, memory, and so on – and its software – the operating system and your programs. The BIOS program is kept in permanent, read-only memory or ROM (although if necessary it can be upgraded by an authorised maintainer).

BIOS Setup is a helpful utility that forms part of the BIOS program. It allows you to view and alter the computer’s hardware configuration. It is also used to configure various security and power-saving options. Configuring the computer is necessary to ensure that the software you use can recognise and exploit the hardware’s capabilities.

The current configuration is kept in a special area of memory, called CMOS memory, and maintained by a battery so that the configuration is preserved even while the computer is switched off.

Your computer arrives already configured, but may need to be configured again after you add or remove add-on options such as memory modules or expansion cards.

Whenever the computer is turned on, the BIOS power-on self-test (POST) routine tests various hardware components, including memory, and compares the actual configuration of the computer with that recorded in permanent (CMOS) memory.

A configuration discrepancy could arise if you have just installed or removed a hardware option (for example, if you have added or replaced memory). In this case you may be diverted directly into the BIOS Setup utility.



## BIOS Setup

---

### Starting BIOS Setup

To start the BIOS Setup utility:

1. Turn on or restart your computer.
2. Wait until the Mitsubishi Electric logo appears on the screen.



3. Press the F2 key.
4. If you have previously defined a Supervisor password, you are prompted for it before BIOS Setup starts.

### If BIOS Setup starts on its own

BIOS Setup might start on its own for three reasons:

- ◆ The power-on self-test (POST) detects a configuration error or fault. This may be signalled by one or more POST error messages. If a persistent fault is indicated, make a note of any error messages and the current configuration settings before calling an authorised maintainer.
- ◆ The CMOS battery may be running down. This may cause spurious POST error messages. If this happens every time you turn on the computer, you may have to change the battery (see the *Motherboard Features & Upgrades* chapter).
- ◆ The computer's configuration may have changed, for example by the addition of more system memory or an expansion card. In this case you may have to define the new configuration.

Press	To
F1 or ALT-H	View a general help topic. Press ESC to close the help window.
ESC	Exit the current menu.
LEFT or RIGHT arrow	Select a different menu.
UP or DOWN arrow	Select fields on the current menu.
PLUS (+) or F6 or SPACEBAR	Select the next value for the current field.
MINUS (-) or F5.	Select the previous value for the current field.
ENTER	Execute a command or enter a sub-menu.
HOME or END	Move the cursor to the top or bottom of the current menu.
PAGE UP or PAGE DOWN	Move the cursor to the next or previous page of the current menu.
F9	Restore the default settings for all menus.
F10	Save the changes you've made and exit from BIOS Setup.

## Control keys

Use the keys listed in the legend bar at the bottom of the BIOS Setup screen to make your selections or exit the current menu.

Sub-menus are marked by a ► pointer. To display a sub-menu, use the arrow keys to move the cursor to the sub-menu you want, then press ENTER.

Changeable fields are enclosed in square brackets. To select an item, use the arrow keys to move the cursor to the field you want. Then use the PLUS (+) and MINUS (-) keys to select a value for that field.

---

### Caution

*The default BIOS settings may not be appropriate for your particular system. Make a note of the current settings before pressing F9 or using the Load Setup Defaults command of the Exit menu.*

---

### **Getting help in BIOS Setup**

You can at any time get general help about the control keys by pressing the F1 key.

The help window on the right-hand side of each menu displays help text for the currently-selected field. It changes as you move the cursor from one field to another.

### **Reserving ISA legacy resources**

To reserve interrupts and upper memory block (UMB) regions for ISA expansion cards, go to the Advanced menu, select PCI Configuration, then select PCI/PNP ISA IRQ Resource Exclusion or PCI/PNP ISA UMB Region Exclusion as required.

## **Power-on self-test**

---

### **Recoverable POST errors**

Whenever a recoverable (non-terminal) error occurs during POST, the BIOS displays an error message describing the problem (the most usual are described below). After some messages, you may be prompted to **Press <F1> to resume, <F2> to enter Setup** or just **Press <F2> to enter Setup**.

In general, you should respond to these errors as follows:

- ◆ Shut down the computer, wait 20 to 30 seconds, and then turn it on again to see if the problem is still reported.

- ◆ Check that all external cables are securely connected.
- ◆ Try running the BIOS Setup utility to reconfigure the system. If the computer won't start after you make changes in BIOS Setup, try restoring the original values.
- ◆ Open up the system unit and check that all internal signal and power cables are securely connected.
- ◆ If the problem persists, contact your supplier or authorised maintainer.

**Diskette drive A error**

Drive A: is present but fails the POST diskette tests. Check that the drive is defined correctly in BIOS Setup. If necessary, open the system unit and check that the drive's signal (ribbon) cable is connected.

**System/Extended/Shadow RAM failed at offset: *xxxx*  
Failing bits: *yyyy***

System, extended or shadow memory is not working, or not configured properly, at offset *xxxx*. The hexadecimal number *yyyy* is a map of the bits at the address which failed the memory test. Each "1" in the map represents a failed bit.

**Fixed disk X failure or Fixed disk controller failure**

A fixed (hard) disk drive is not working or not configured properly. Check that the drive is defined correctly in BIOS Setup. If necessary, open the system unit and check that the drive's signal (ribbon) cable is connected.

**Incorrect drive A type - run SETUP**

The diskette drive is not correctly specified in BIOS Setup.

**Invalid NVRAM media type**

Problem with NVRAM (non-volatile random-access memory).

**Keyboard error [*nn*] or Keyboard controller error**

There is a problem with the keyboard or (less likely) the standard I/O controller on the motherboard. If POST discovers a stuck key it displays its scan code.

**Operating system not found**

An operating system cannot be located either on a system diskette or on a hard disk. Start BIOS Setup and check that the diskette and/or hard disk drives are specified correctly.

**Parity check 1 *xxxx* or Parity check 2 *xxxx***

Parity error found on the system (1) or I/O (2) bus. The BIOS attempts to locate and display the address *xxxx*. If it cannot locate the address, it displays "????".

**Previous boot incomplete - default configuration used**

The previous POST did not complete successfully. POST loads default values and offers to start BIOS Setup. If the failure was caused by incorrect values and they are not corrected, the next boot will likely fail too.

**Real-time clock error**

A service engineer may need to replace your motherboard.

**System battery is dead - replace and run Setup**

Replace the configuration battery as instructed in the *Motherboard Features & Upgrades* chapter, then use BIOS Setup to reconfigure the system.

**System cache error - cache disabled**

The RAM cache failed POST and BIOS disabled it.

**System CMOS checksum bad - run Setup**

System CMOS has been corrupted or modified incorrectly, perhaps by an application program that changes data stored in CMOS. Run BIOS Setup and reconfigure the system either by getting the default values or by making your own selections.

**System timer error**

A service engineer may need to replace your motherboard.

Code	Beeps	Test which failed
16	1-2-2-3	BIOS ROM checksum
20	1-3-1-1	DRAM refresh.
22	1-3-1-3	8742 keyboard controller
2C <i>xxxx</i>	1-3-4-1	RAM failure on address line <i>xxxx</i> .
2E <i>xxxx</i>	1-3-4-3	RAM failure on data bits <i>xxxx</i> of low byte of memory bus.
30 <i>xxxx</i>	1-4-1-1	RAM failure on data bits <i>xxxx</i> of high byte of memory bus.
46	2-1-2-3	Check ROM copyright notice
58	2-2-3-1	Test for unexpected interrupts
98	1-2	Video configuration failure, or option ROM checksum failure. (One long, two short beeps.)

### Terminal POST errors and beep codes

There are several POST routines that shut down the computer if they fail. If possible, the BIOS displays a two-digit hexadecimal code and/or sounds a sequence of beeps to identify the point at which POST failed. The most usual errors are listed in the table on the left.

The BIOS also issues one long tone followed by two short tones if the video system is faulty or if an external ROM module (including video ROM) fails.

Turn off the computer for 30 seconds and then try again. If the fault persists, make a note of the error code (if any) and call your supplier or authorised maintainer.

## 8 TROUBLESHOOTING

This chapter offers advice if you suspect a fault with your computer. It is concerned mainly with problems caused by the computer itself; problems more often arise from other sources such as your operating system or application software.

It must also be remembered that it can be very easy to leave off or dislodge cables inside the computer when fitting expansion cards, or upgrading the motherboard, or indeed anything that requires temporary removal of the system cover.

---

### **If you are apprehensive**

*Make a note of any of the symptoms, error codes, displayed messages and so on, then turn off the computer and unplug all power cords before consulting your supplier or maintenance provider.*

---

### **If something goes wrong ...**

- ◆ Read this chapter.
- ◆ Review the rest of this manual to make sure you are operating the computer correctly.
- ◆ Read the on-line Help. (For help with Easy Manager, click the Mitsubishi Electric symbol in the Windows taskbar, then click **Help**.)
- ◆ Consult your Mitsubishi Electric PC supplier or authorised maintainer.

## Problems when starting

---

### If you suspect a blown fuse

In the United Kingdom, and some other countries, AC plugs contain fuses. If the fuse in the system's unit AC plug blows when you turn on the computer, this may be caused by an AC power surge, but is more often a symptom of problems with the computer or its peripherals. Follow these steps:

1. Turn off the computer and unplug all power cords.
2. Unplug all peripherals.
3. Try to discover the cause of the fault. If none is apparent, replace the blown fuse with one of the same rating, reconnect the system unit power cord and try to turn it on again.
4. If the replacement fuse blows, call your supplier or maintenance provider.

If the replacement fuse does not blow, reconnect a peripheral and turn it on. Repeat this step for each peripheral in turn.

### Power-on self-test (POST)

Whenever the computer is turned on, the BIOS POST routine tests various hardware components, including memory, and compares the actual configuration of the computer with that recorded in CMOS memory.

If POST detects a hardware fault, one or more POST error codes or messages may be displayed. See the *BIOS Setup & POST* chapter for more information and advice.

### Failure to boot

On completion of POST, the computer attempts to boot from a system diskette or bootable hard disk partition. The table below lists some of the messages that might appear during the boot sequence.

### Non-system disk or disk error

The diskette drive contains a non-system diskette. Either remove it, or replace it with a system diskette, and press F1.



**Diskette read failure**

The diskette is either not formatted or defective. Either remove it, or replace it with a system diskette, and press F1.

**No boot sector on fixed disk**

The hard disk has no active, bootable partition or is not formatted. If you are still using the original master hard disk drive supplied with your computer, this is a serious problem requiring the attention of a service engineer. If you have just replaced the master drive with an unformatted one, you must insert a system diskette, press F1, and format the new hard disk as described in your operating system manuals.

**Fixed disk read failure**

The hard disk may be defective. Press F1 to retry. Make sure the drive is correctly specified in the BIOS Setup utility. If the problem persists, insert a system diskette, press F1, backup the data held on the defective hard disk and try reformatting it.

**No boot device available**

This may indicate a fault in the diskette or hard disk drive, or perhaps a damaged system diskette. Press F1 to retry, using another system diskette, if possible. Make sure that a boot device is correctly specified with the BIOS Setup utility. If the problem persists contact your supplier or authorised maintainer.

## Common problems

---

If you encounter a problem with the computer the following sections suggest checks to make before you alert your supplier, authorised maintainer or support organisation. The checks listed cover the causes of common problems.

### **Connections**

Check that all power and signal cables are securely connected to the correct port on the computer.

The keyboard and mouse are particularly easy to connect into the wrong port. Although the connectors are identical, the keyboard will not work if plugged into the mouse port, and vice versa.

### **Power**

Check that the AC power supply is switched on, and that the fuse in the AC plug (if any) has not blown. If the system still does not seem to be getting power, obtain another power cord from your supplier.

### **Monitor**

If there is no display check that the computer is not in an energy-saving mode (see the *Welcome* chapter), that the monitor is turned on, and the brightness and contrast controls are not too low.

If you have fitted a new video controller expansion card and subsequently encounter problems try disabling the on-board video controller by removing a jumper from the motherboard. See the *Motherboard Features & Upgrades* chapter for more information.

### **Mouse**

If the screen cursor moves jerkily, the ball inside the mouse may require cleaning. Open the base of the mouse can clean the ball in water mixed with a small amount of mild detergent. Clean any grease and dust from the rollers inside the mouse with a cotton swab moistened with a solvent cleaner.

**Keyboard**

If the keyboard response is poor, something may be trapped under the keys. Turn the keyboard upside down and shake it; do not probe between the keys as this may cause further damage.

If you spill something on the keyboard and it stops working:

- ◆ If the liquid is viscous, unplug the keyboard and call your supplier or an authorised maintainer.
- ◆ If the liquid is thin and clear, try unplugging the keyboard, turning it upside down to let the liquid drain out, and drying it for at least 24 hours at room temperature. If the keyboard still won't work, call your supplier or an authorised maintainer.

**Expansion cards**

If an expansion card does not work, check that all internal cables are securely connected, that the card is configured correctly, that its use of system resources does not conflict another card or motherboard component, and that legacy resources (if it is an ISA card) are properly declared in the BIOS Setup utility. Check also that the software which drives or uses the card is correctly configured.

**System BIOS**

Use the BIOS Setup utility to ensure that the settings are correct. If the settings appear to have altered, there may be a fault with the CMOS battery which may need to be replaced (see the *Motherboard Features & Upgrades* chapter for instructions).

### **Diskette drive**

If you have problems accessing a diskette, check that it is inserted correctly, that it has been correctly formatted, that it is not write-protected, and that the diskette drive controller is enabled. Some application software also may not allow you to read or write to diskettes during certain other operations, or until you are about to exit the program.

### **CD-ROM drive**

If you have problems accessing a CD, check that you have allowed a few seconds for the disk to spin up to full speed, that the disk is the correct way up in the drive (printed side upwards) and that it is a data CD. Remember that with a conventional CD-ROM drive you cannot write to a CD.

### **Hard disk drives**

If you encounter problems accessing a hard disk drive, use the BIOS Setup utility to check that the drive is correctly specified, and that the drive's controller is enabled. Check also that the disk has been correctly formatted, and that the permissions assigned by the operating system allow the intended access.

### **Overheating**

If the system processor starts to overheat, it will automatically slow down or stop altogether. The computer is designed to operate in room temperatures between 10 and 35 °C. If the room temperature is within these limits, turn off the computer, unplug all power cords and check that the power lead of the processor's fan-sink (combined fan and heat sink) is properly connected to the motherboard. See the *Motherboard Features & Upgrades* chapter for help in identifying the right motherboard connector.



# EQUIPMENT LOG

Use this equipment log to record pertinent information about your PC.

In particular, you must record the 12-digit fall-back password of the Electronic Fingerprinting security feature (see the *Quick Start Guide* for more information).

Record the password in the space provided below, then store this page (or the whole manual) in a safe place.

**Fall-back password:**

<input type="text"/>	<input type="text"/>	<input type="text"/>	<input type="text"/>	<input type="text"/>	<input type="text"/>	<input type="text"/>	<input type="text"/>	<input type="text"/>	<input type="text"/>
----------------------	----------------------	----------------------	----------------------	----------------------	----------------------	----------------------	----------------------	----------------------	----------------------

**Manufacturer's data**

You should record the model codes and serial numbers of the system components. You can update this with information about any expansion cards fitted.

	Model	Serial number
System unit		
Monitor		
Keyboard		
Mouse		

	Model	Serial number
Speakers		
Sub-woofer		

***Expansion cards***

	Manufacturer	Description	Serial number
1			
2			
3			
4			
5			



16006731



APRICOT MULTIMEDIA PCs

<http://www.mitsubishi-computers.com>

**MITSUBISHI ELECTRIC  
PC DIVISION**

Apricot Computers Limited  
3500 Parkside  
Birmingham Business Park  
Birmingham B37 7YS  
United Kingdom

Tel +44 (0) 121 717 7171  
Fax +44 (0) 121 717 7799

**MITSUBISHI ELECTRIC  
PC DIVISION**

Apricot Computers Limited  
Niederlassung Deutschland  
Gothaer Strasse 27  
40880 Ratingen  
Germany

Tel +49 (0) 2102 4556  
Fax +49 (0) 2102 455700